



Instructions for Inverter Monitoring Software

Index

1. Introduction

2. Installation and wiring

1. Accessories

2. Installation instructions

- Hardware
- Install software

3. Run software – start up the monitoring menu

4. Operating instructions

1. Setting

2. Statistics

3. Remote on-off

4. Pause

5. Release Note

6. Exit

5. Explanation of various monitoring status

1. Inverter

2. By Pass

3. Solar Charge

4. AC Charge

5. Loading

6. LED status indication

7. Battery capacity

1. Introduction :

The goal of inverter monitoring software is to provide a user friendly interface. After installing this software on a PC, the user will be able to monitor inverter status from a remote area and remotely turn the unit ON/OFF. User will have the flexibility to change between operating modes (USP or energy saving), voltage, and frequency setting anytime they feel the need to.

2. Installation & wiring :

1. Accessories (RJ11~RS-232 cable and RS-232~USB converter can be optionally purchased)

- RJ11~RS-232 cable

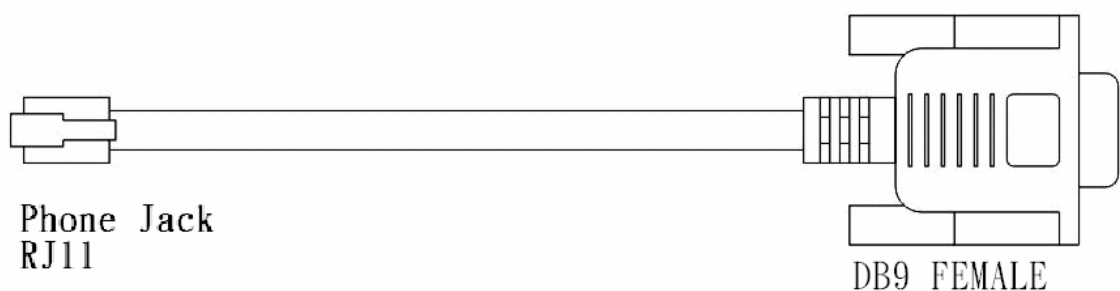

- RS-232~USB converter (MOXA UPort 1110)

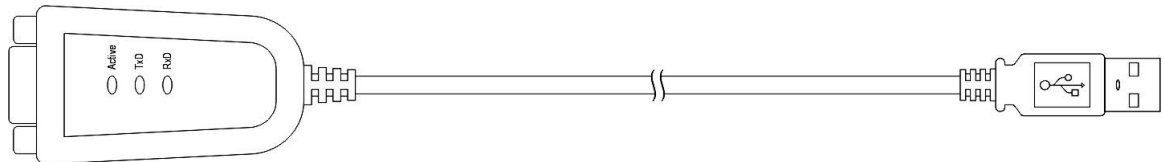

- Monitoring software CD



- RS-232~USB Driver CD



2. Instructions on installation

• Hardware assembly

(A) PC/Notebook with RS-232 COM port

First make sure the inverter is operating normally then attach the RJ-11 - RS-232 cable between the inverter (RJ-11) and PC (RS-232). Refer to the diagram below:

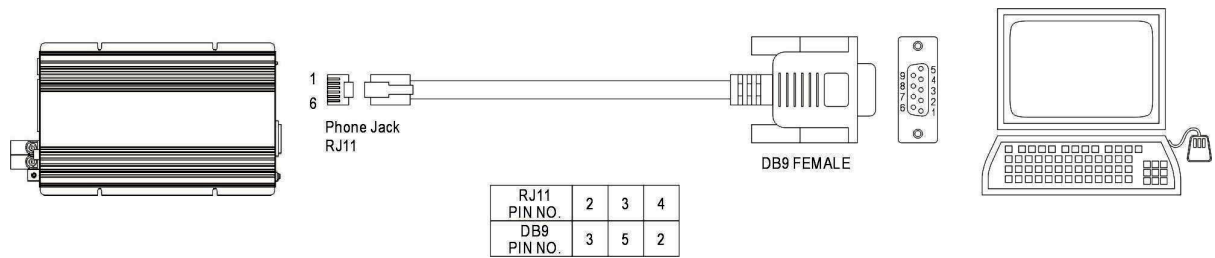

(B) PC/Notebook with USB COM port

In case the PC/Notebook does not provide RS-232 COM port and only has USB available, an USB - RS-232 converter can be used. The RS-232 - USB converter and RS-232 - RJ-11 cable can first be connected in series before connecting between inverter (RJ-11) and PC/notebook (USB). Refer to the diagram below:

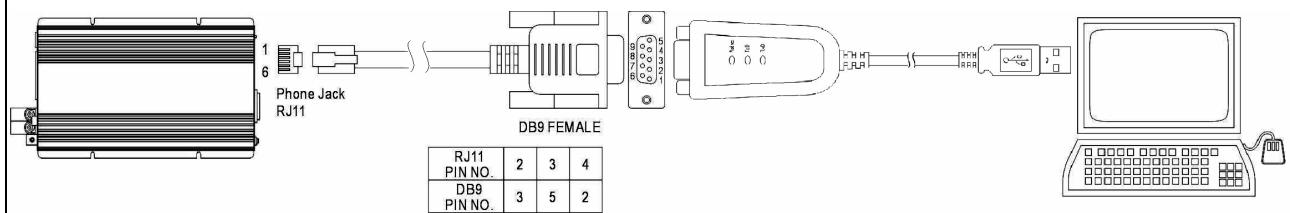

When a MOXA converter is used to achieve connection between inverter and PC, the PC should be powered-on first before inserting the USB end of the MOXA converter, otherwise proper communication link can not be made.

• Install software

Step 1. Insert the monitoring software CD into the CD-rom drive of the PC. Hit “setupxxx” (xxx represents the version no.) to install.



Step 2. Click on ” Next” to advance to next step

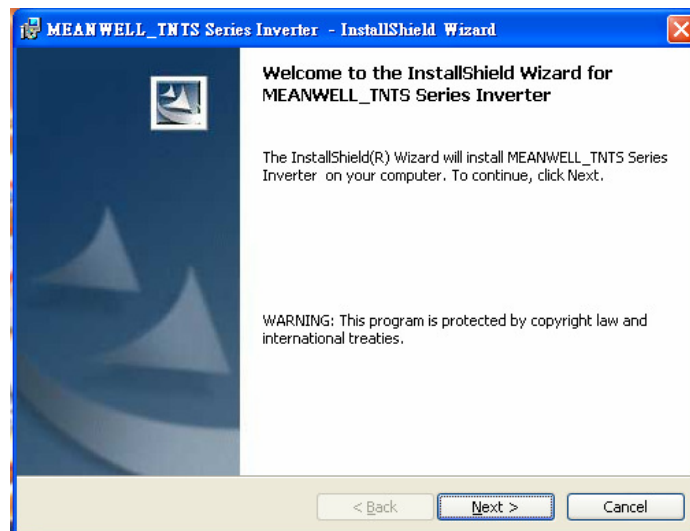

Step 3. Please choose “typical” as the setup type

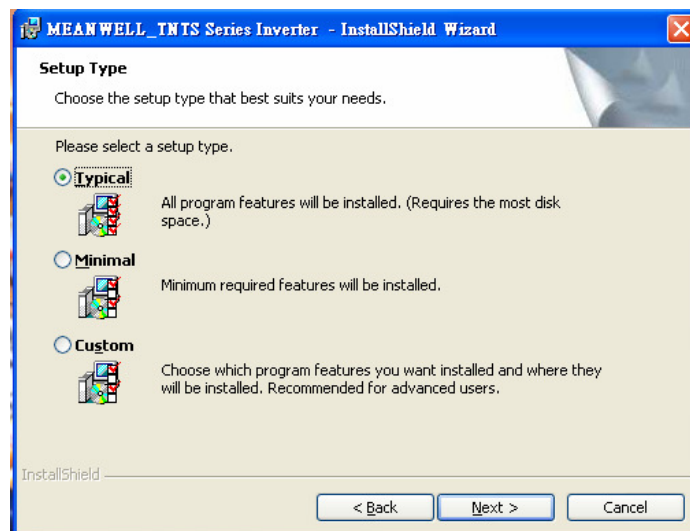

Step 4. click-on " Install" to proceed with installation

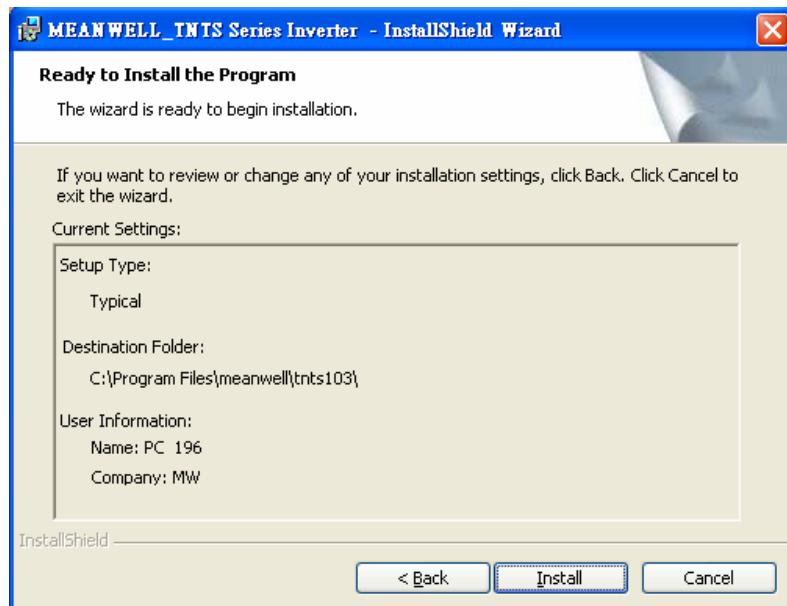

Step 5. When installation is complete, click-on " Finish" to close window

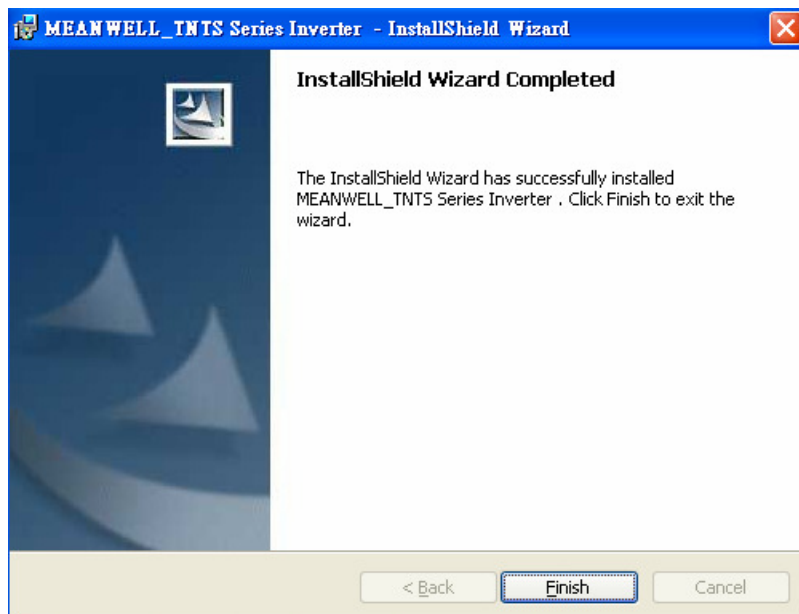

※ This software is only suitable for Microsoft operating system. It is not compatible with Linux.

※ If USB - RS-232 converter is required, please remember to install the driver software for the MOXA USB converter.

2. Run software - start up the monitoring menu :

After the monitoring software is installed, a short-cut will appear on the Window desktop. Click-on the following icon to run the software.



1. Establish communication :

While starting the monitoring software, a communication check between the inverter and PC/notebook will automatically be performed. When inverter is detected, the monitoring menu will pop up:

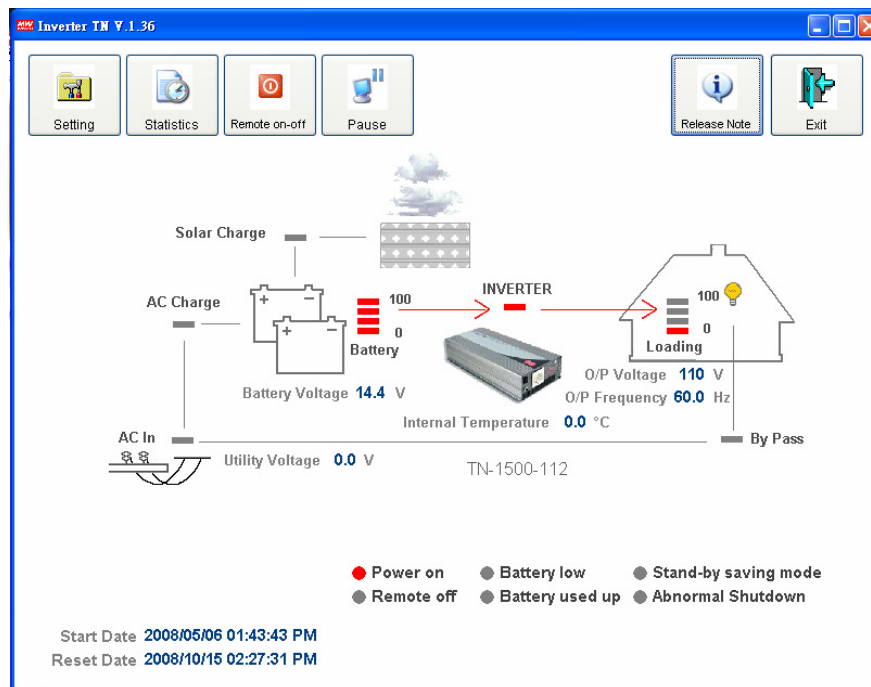

2. Communication failure :

If there is a failure in communication, the message "inverter not found" will be displayed:

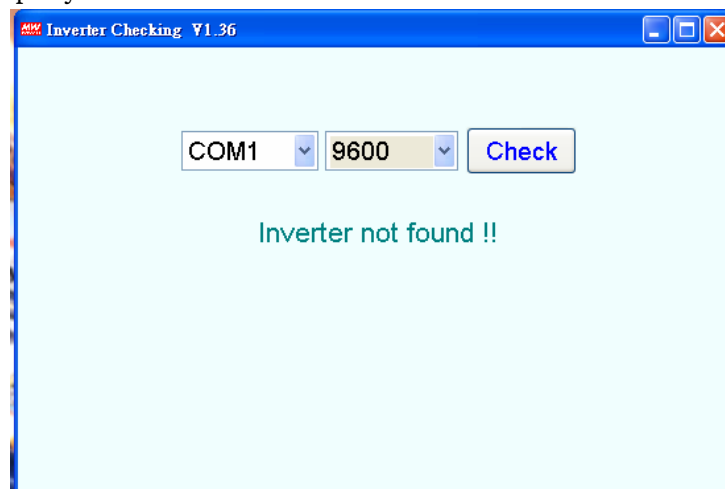

To bypass error: First make sure the COM port setting are the same for both the software and PC/notebook. This can be done by checking the PC's hardware manager. Also, check for possible loose cable connection.

4. Operating instructions:

1. **Setting:** Click to enter setting menu (gray background means that particular setting is not adjustable)

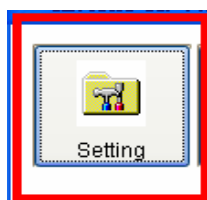

File Name:

Directory for loading in a file.

Model Name:

Inverter model

Manufacture :

Product manufacturer (Mean Well).

Revision :

Inverter firmware version

I/O Type :

Inverter IP/OP type

Voltage :

Output voltage selection. User can choose between 100/110/115/120V or 200/220/230/240V .

Frequency :

Output frequency selection. User can choose between 50Hz or 60Hz .

Stand-by saving mode :

It can be activated to save battery power when no load is connected (<=5W). The factory setting is ON.

Energy saving mode :

Solar input will have priority (either energy saving or USP can be selected)

UPS mode:

AC utility will have priority (the factory default is UPS mode, mode adjustment can easily be made depending on actual operating requirement)

Equalization Volt. :

Quick charge voltage. It is user adjustable.

Floating Volt. :

Fully charged voltage. It is user adjustable.

Alarm Volt. :

Alarm for battery under voltage. It is user adjustable.

Shutdown Volt. :

Battery low shutdown. It is user adjustable.

Transfer Volt. :

The by pass battery voltage for energy saving mode.

Comm Ports :

PC to TN-1500 COM port setting. Both software and hardware must match.

Bauds Rate :

Date transfer rate. The factory default is 9600.

Read :

To check current setting of the inverter, click-on the **Read** icon and inverter status will be displayed on screen.

Write :

Click-on **Write** to write new setting into the inverter. User must wait 10 seconds for the inverter to restart before execution other commands.

Load :

Load previously saved setting file (*.TNF)

Test :

After loading in a file by clicking the **Load** icon, the Test function can be performed to check if current inverter settings and the loaded settings are the same.

Exit:

Exit setting menu

Explanation: User will be able to change the equalization, float, alarm, and shutdown setting for the battery as long as it is within the predefined range. When the range is exceeded a warning message will appear on screen (see below). Correction must be made prior to writing in the new setting.

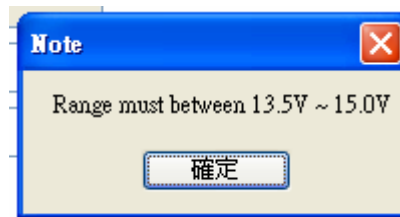

2. Record of data communication (Statistics) : Click to enter Statistics menu.

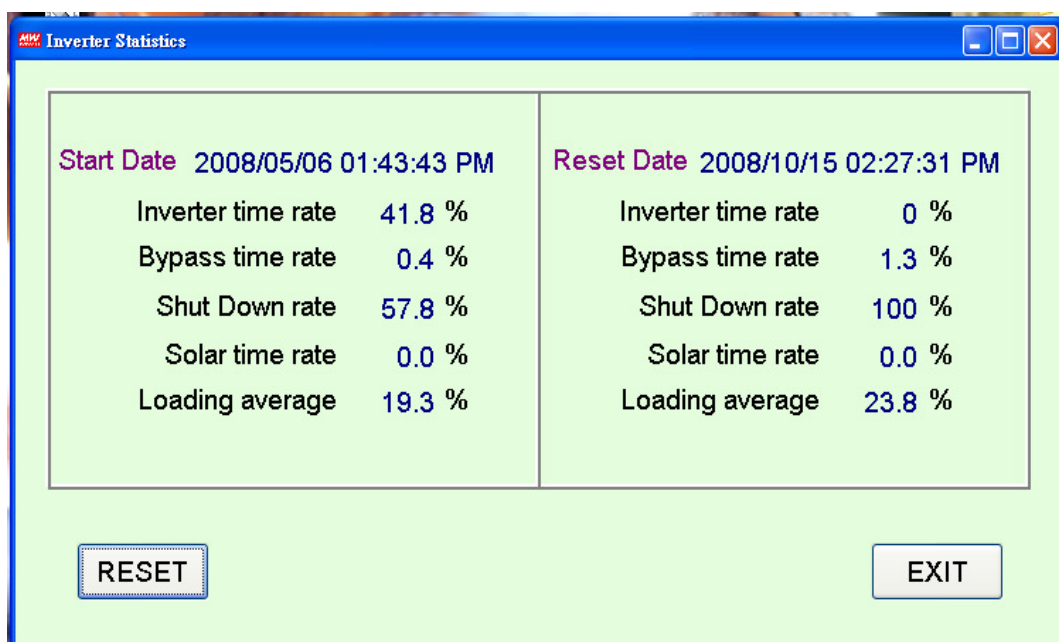

Start Date (Installation date) : Statistics is accumulated from the day of installation.

Reset Date: The restart date for data accumulation. Restart occurs when the **RESET** icon is pressed or when the inverter shuts down and restarts.

Inverter time rate : Inverter mode percentage

Bypass time rate : Bypass mode percentage

Shutdown rate : Shutdown mode percentage

Solar time rate : Solar mode percentage

Loading average : Loading percentage

※ Inverter mode + Bypass mode + Shutdown mode = 100%

3. Remote on-off : Remote on/off icon allows for inverter ON/OFF control from a remote PC platform

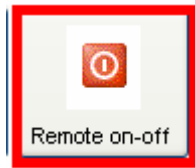

After clicking the Remote on/off icon, the following window will appear.

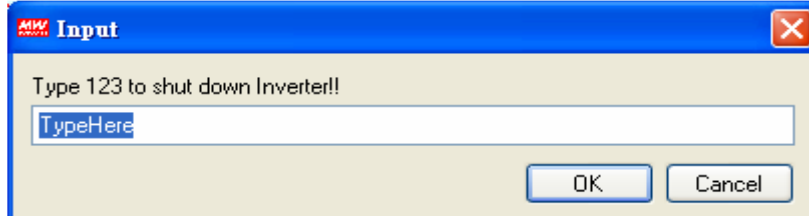

At TypeHere enter “123” then press OK and the inverter will turn OFF after it gives out a “beep.” The Remote ON indication on the monitoring menu will now change to Remote OFF which confirms it’s off status. Refer to the menu below :

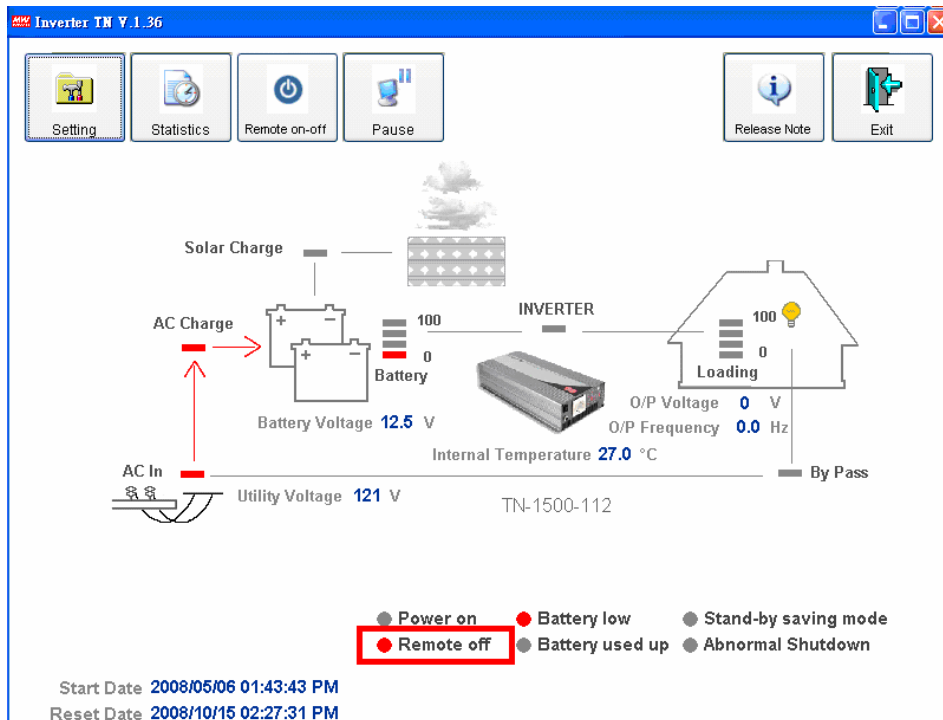

To turn the inverter back ON, click-on the Remote on-off icon, the inverter will come back online after a “beep.” The “Remote off” indication on the monitoring menu will change back to “Remote on” confirming the ON status. Note : After executing Remote off, the load indicator on the TN-1500 face plate will signal 1010 with red LED in a flashing pattern.

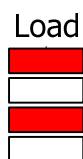

3. Pause : Click on the Pause icon to freeze monitoring of inverter. To continue, click on the icon once more.



5. Release Note : Click for software info.

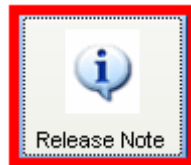

6. Exit : Click to exit software program.





5. Explanation of various monitoring status

- 1. INVERTER :** User will be able to see on the monitoring menu whether output voltage is provided through AC utility or inverter. The indicating method is as follows:



Internal Temperature **14.0 °C**

Explanation of indicator :

-  Output power provided by bypass AC utility
-  Output power provided by inverter

- 2. By Pass :** Inverter status such as output voltage, frequency, activation of Bypass mode can be checked by viewing the monitoring menu. It will be presented in the following manner.

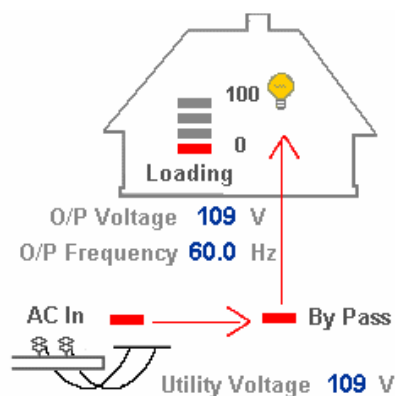

Explanation of indicator :

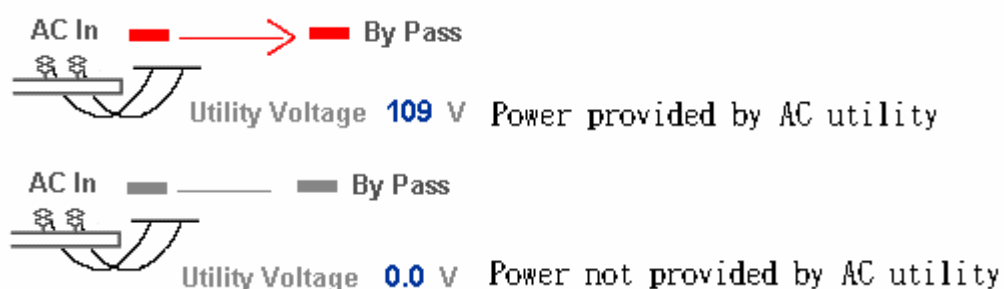

4. Solar Charge : On a clear day, the symbol “bright sun” will appear on the monitoring menu letting the user know that battery charging is provided through the solar panel. On a cloudy day, the symbol “clouds” will appear on the monitoring menu letting the user know that the solar panel has ceased charging the battery.

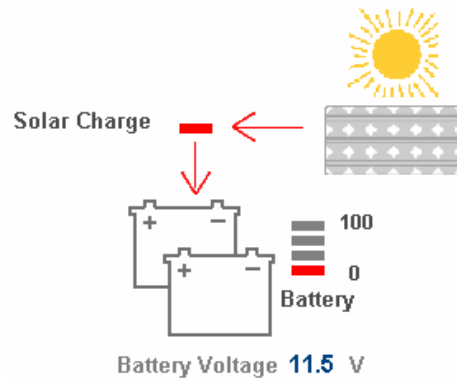

Explanation of indicator :

Solar Charge 



Solar charger is charging the battery

Solar Charge 



Solar charger is not charging the battery

5. AC Charge : User can check the monitoring menu to see if the AC charger is activated. It will be presented in the following manner.

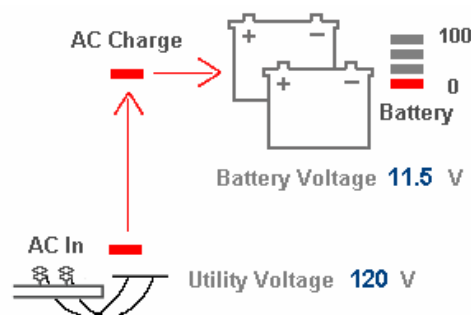

Explanation of indicator :

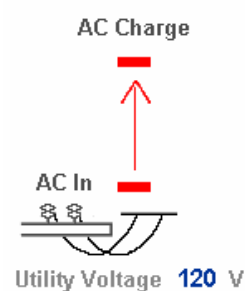

AC charger is charging the battery

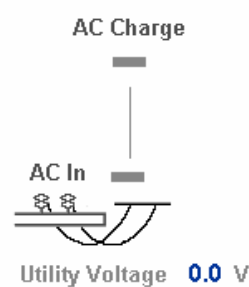

AC charger is not charging the battery

5. Loading : To check loading status, the following diagram can be found on the monitoring menu which shows load percentage.

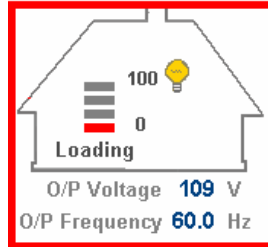

Explanation of indicator :

Indicator display	LED 1 ON	LED 1 ~ 2 ON	LED 1 ~ 3 ON	LED 1 ~ 4 ON
Load usage	0 ~ 30%	30 ~ 50%	50 ~ 75%	75 ~ 100%

6. Light indication : Indicator of various inverter statuses and battery condition can be found in the monitoring menu. Details are as below.

- Power on
- Battery low
- Stand-by saving mode
- Remote off
- Battery used up
- Abnormal Shutdown

Explanation of indicator :

Indicator	Explanation
● Power on	Inverter activated.
○ Remote Off	Remote ON/OFF control.
○ Battery low	When battery capacity too low, inverter buzzer will activate.
○ Battery used up	When battery is used up, inverter will terminate the output.
○ Stand-by saving mode	No load ($\leq 5W$) saving mode.
○ Abnormal Shutdown	Shutdown protection for inverter mode.

7. Battery : To check battery status, the following diagram can be found on the monitoring menu which shows battery capacity in percentage.

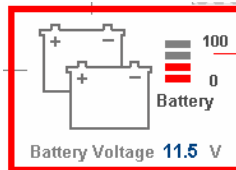

Explanation of indicator :

Indicator display	LED 1 ON	LED 1 ~ 2 ON	LED 1 ~ 3 ON	LED 1 ~ 4 ON
Battery capacity	0 ~ 25%	26 ~ 50%	51 ~ 75%	76 ~ 100%